

$$\cos^2 \alpha + \cos^2 \beta + \cos^2 \gamma = 2$$

▶ Start

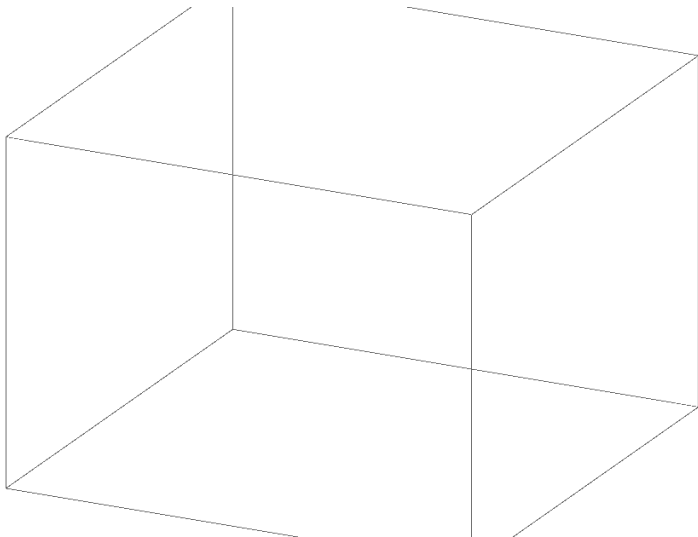

$$\cos^2 \alpha + \cos^2 \beta + \cos^2 \gamma = 2$$

▶ Start

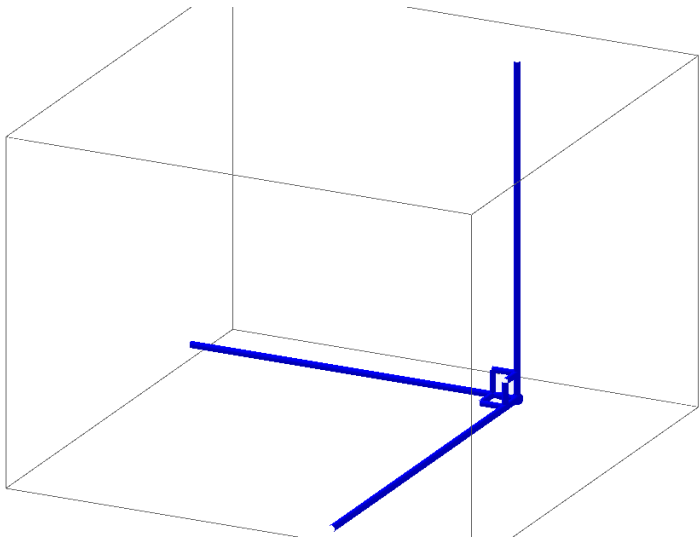

$$\cos^2 \alpha + \cos^2 \beta + \cos^2 \gamma = 2$$

▶ Start

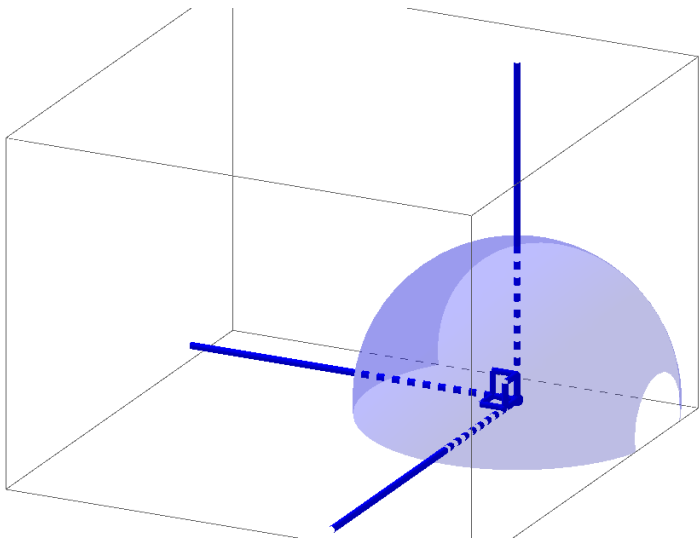

$$\cos^2 \alpha + \cos^2 \beta + \cos^2 \gamma = 2$$

▶ Start

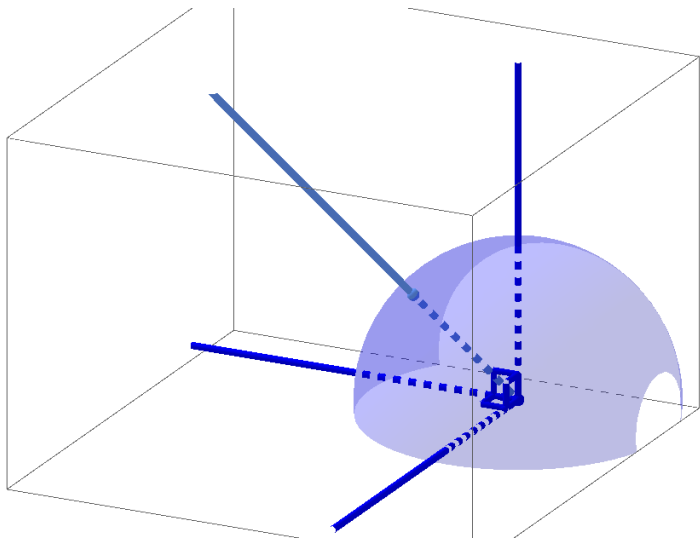

$$\cos^2 \alpha + \cos^2 \beta + \cos^2 \gamma = 2$$

▶ Start

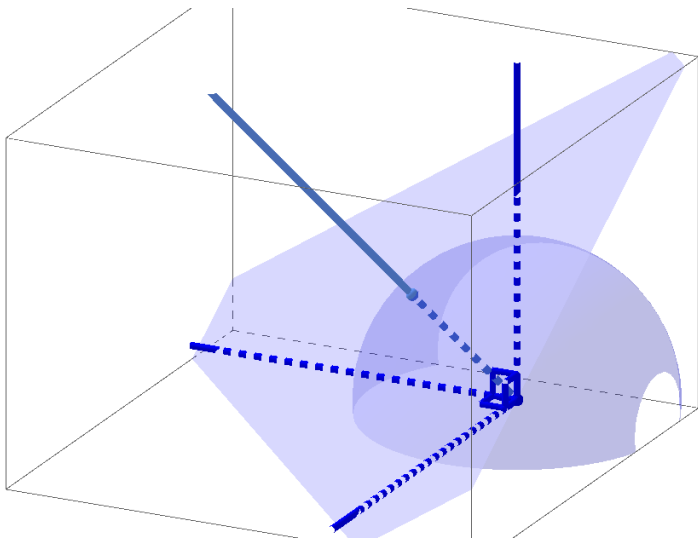

$$\cos^2 \alpha + \cos^2 \beta + \cos^2 \gamma = 2$$

▶ Start

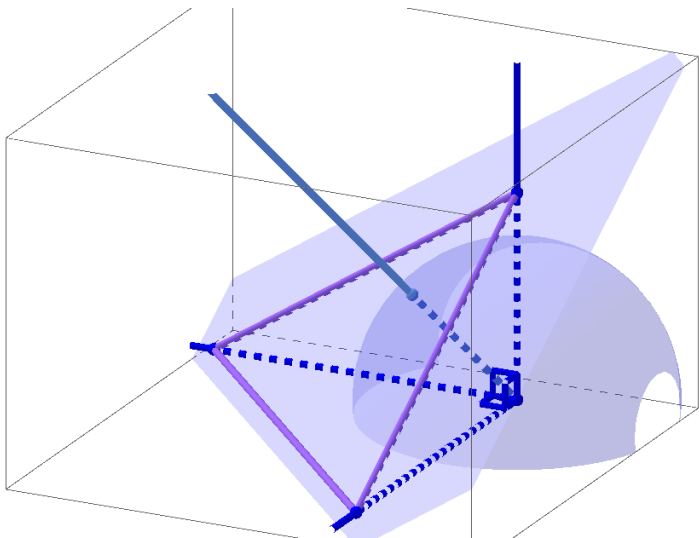

$$\cos^2 \alpha + \cos^2 \beta + \cos^2 \gamma = 2$$

▶ Start

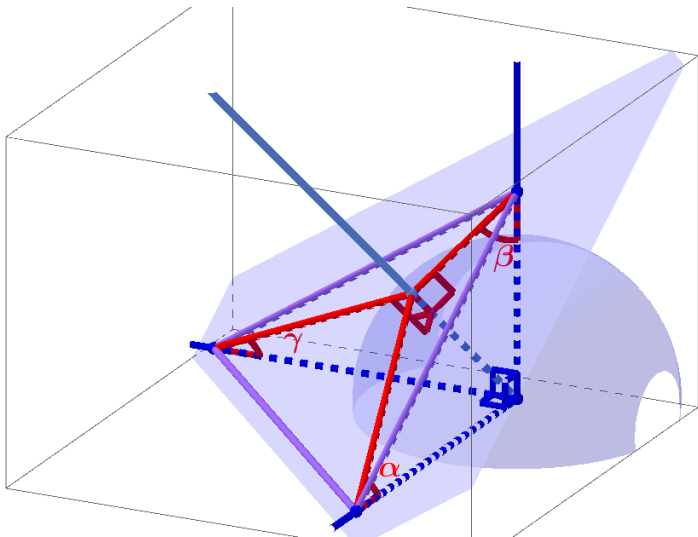

$$\cos^2 \alpha + \cos^2 \beta + \cos^2 \gamma = 2$$

▶ Start

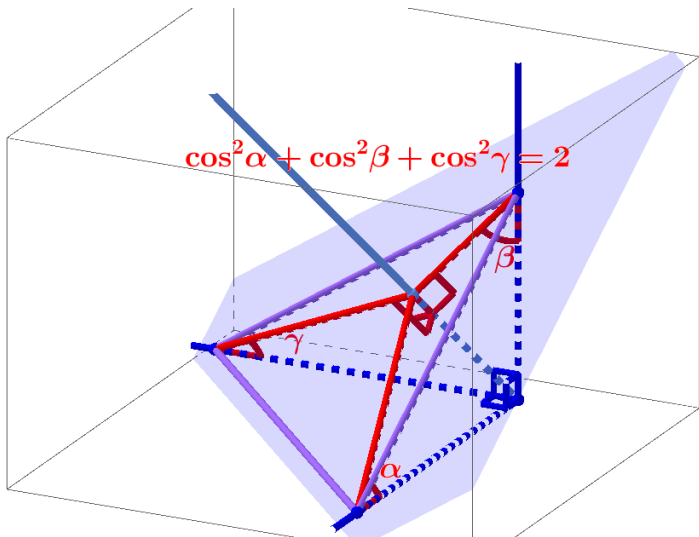

$$\cos^2 \alpha + \cos^2 \beta + \cos^2 \gamma = 2$$

▶ Start

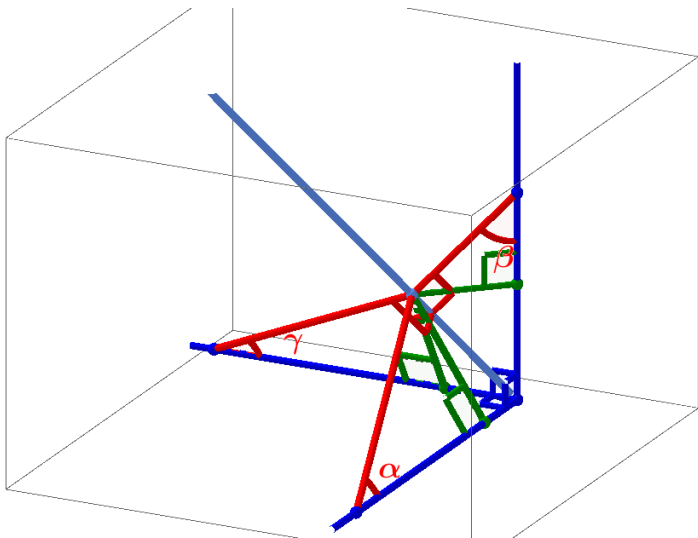

$$\cos^2 \alpha + \cos^2 \beta + \cos^2 \gamma = 2$$

▶ Start

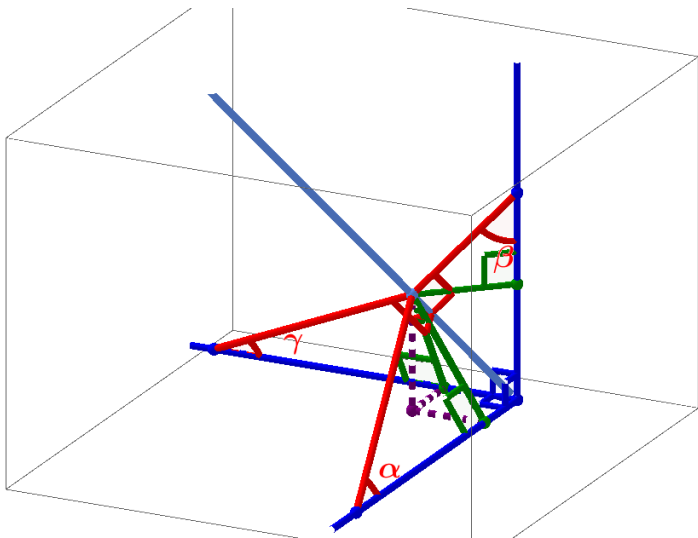

$$\cos^2 \alpha + \cos^2 \beta + \cos^2 \gamma = 2$$

▶ Start

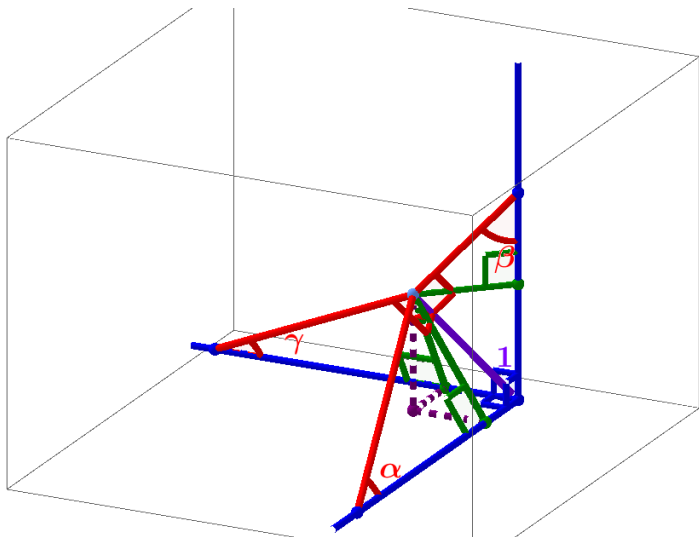

$$\cos^2 \alpha + \cos^2 \beta + \cos^2 \gamma = 2$$

▶ Start

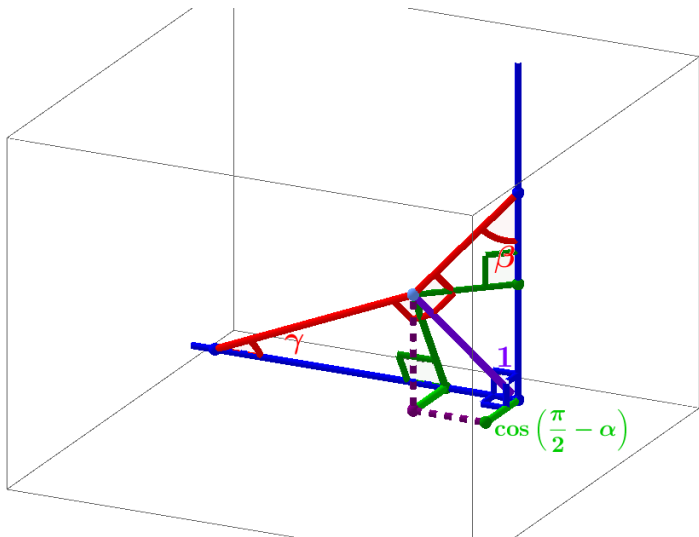

$$\cos^2 \alpha + \cos^2 \beta + \cos^2 \gamma = 2$$

▶ Start

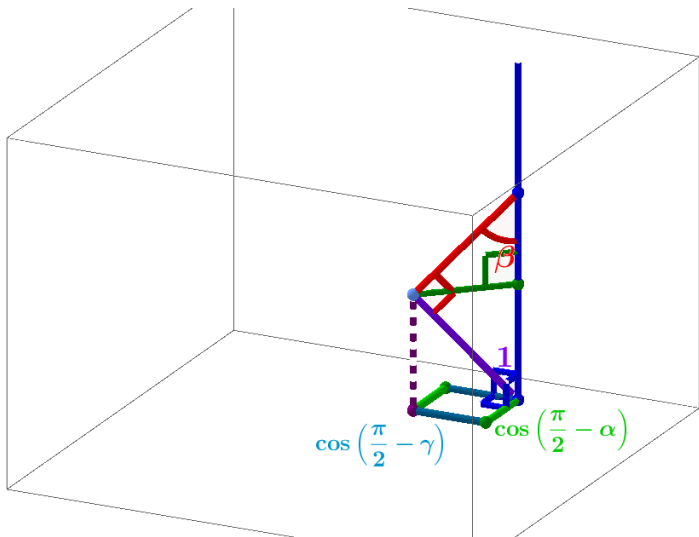

$$\cos^2 \alpha + \cos^2 \beta + \cos^2 \gamma = 2$$

▶ Start

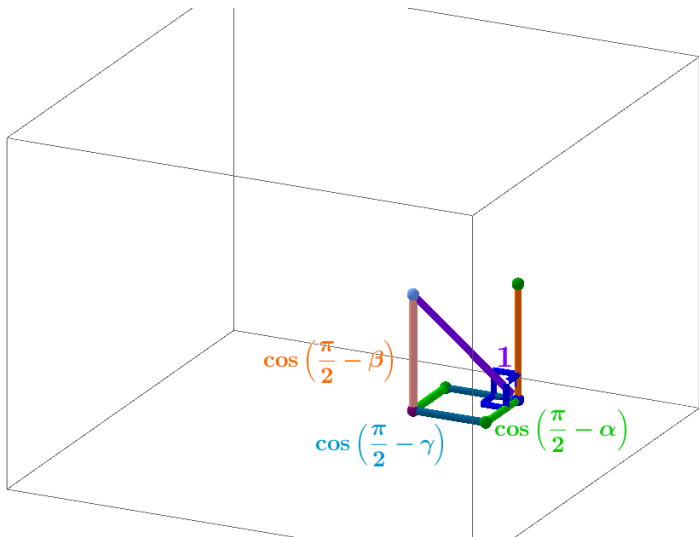

$$\cos^2 \alpha + \cos^2 \beta + \cos^2 \gamma = 2$$

▶ Start

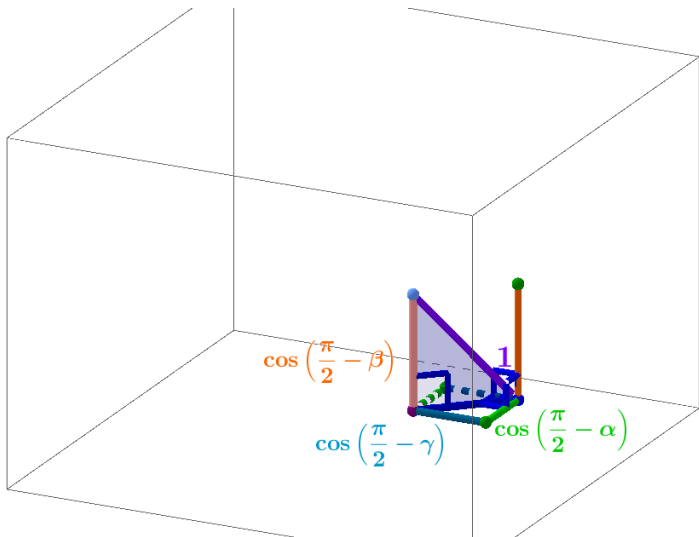

$$\cos^2 \alpha + \cos^2 \beta + \cos^2 \gamma = 2$$

▶ Start

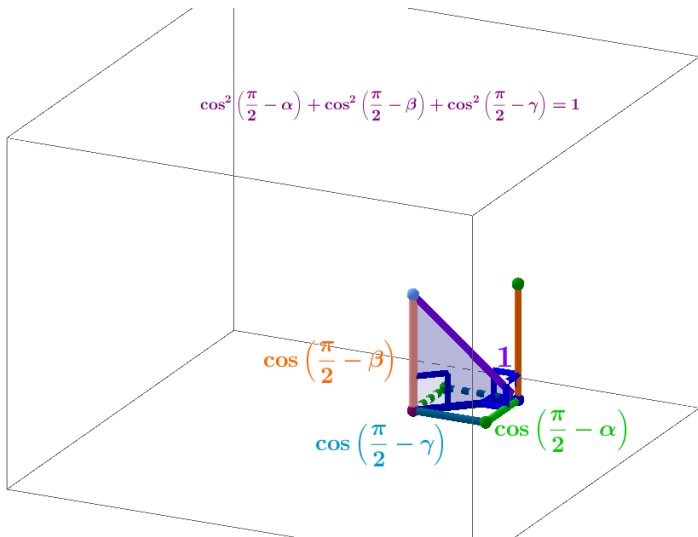

$$\cos^2 \alpha + \cos^2 \beta + \cos^2 \gamma = 2$$

▶ Start

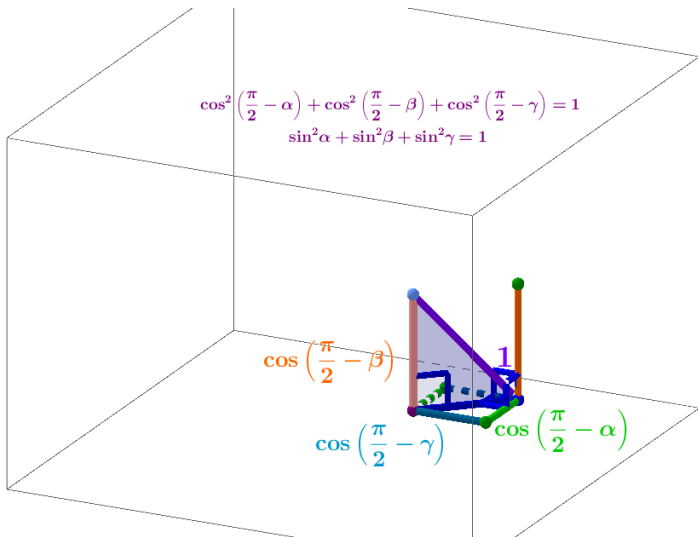

$$\cos^2 \alpha + \cos^2 \beta + \cos^2 \gamma = 2$$

▶ Start

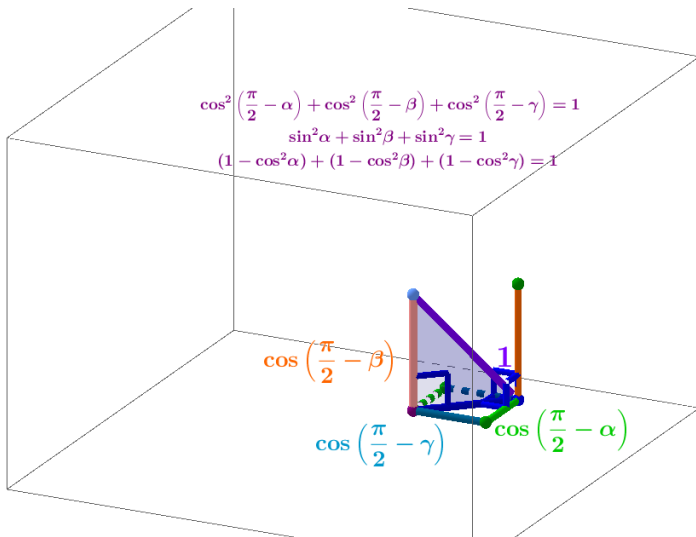

$$\cos^2 \alpha + \cos^2 \beta + \cos^2 \gamma = 2$$

▶ Start

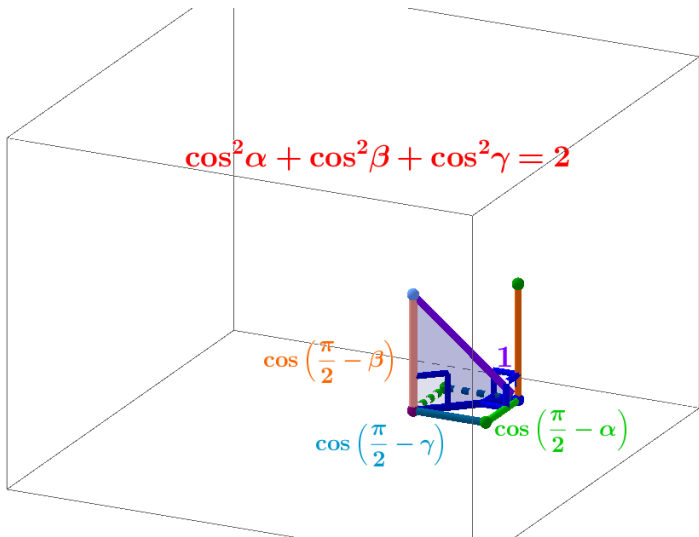

$$\cos^2 \alpha + \cos^2 \beta + \cos^2 \gamma = 2$$

▶ Start

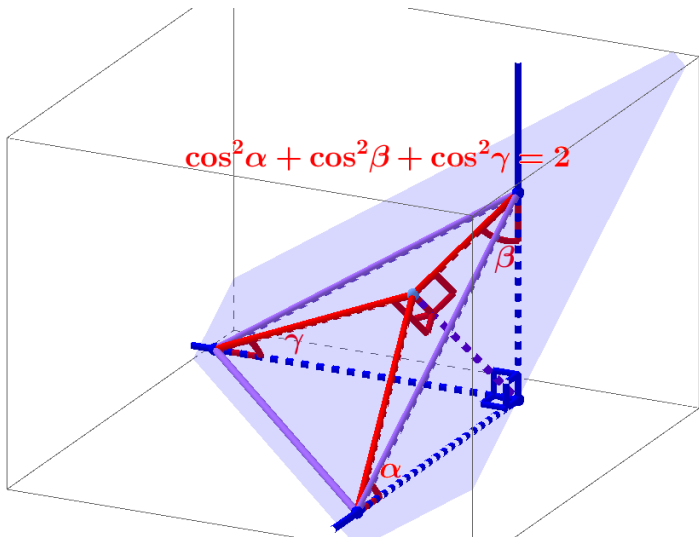

$$\cos^2 \alpha + \cos^2 \beta + \cos^2 \gamma = 2$$

▶ Home

