

주어진 선분과 주어진 직선 상의 점으로 직각 삼각형 만들기

1 2 3 4 5 6 7 8 9

1 2 3 4 5 6 7 8 9

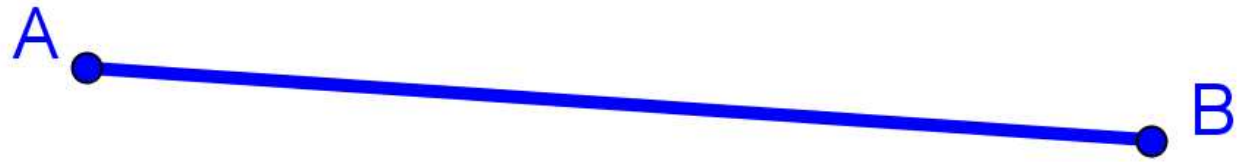

1 2 3 4 5 6 7 8 9

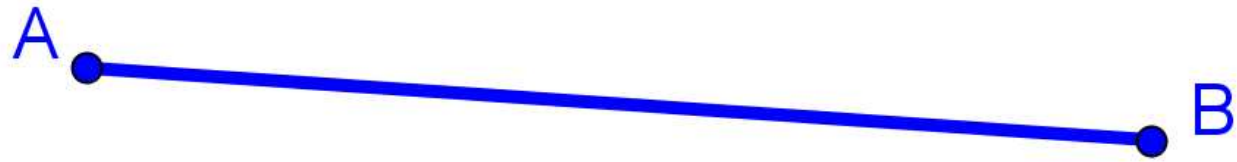

1 2 3 4 5 6 7 8 9

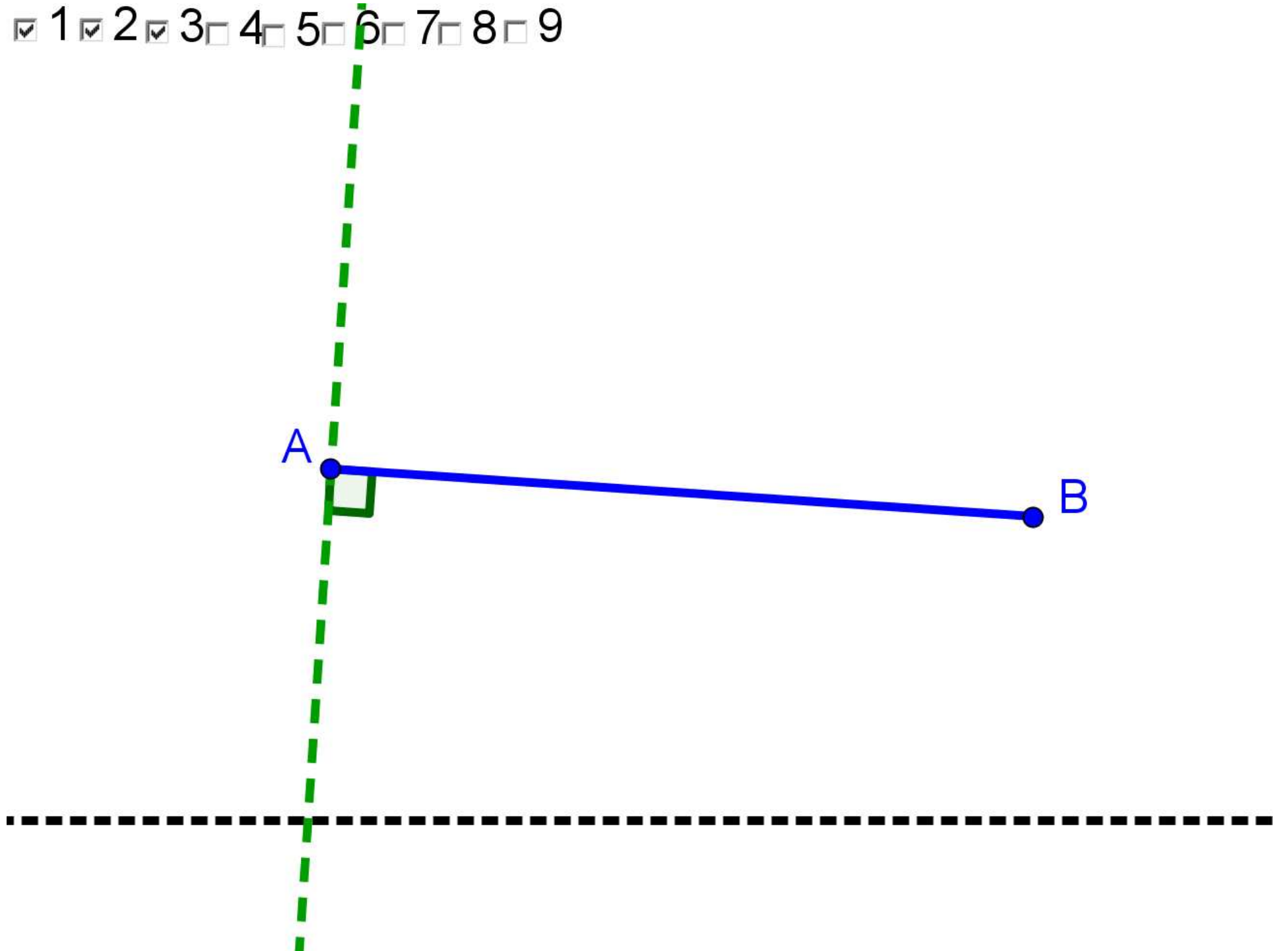

- 1
- 2
- 3
- 4
- 5
- 6
- 7
- 8
- 9

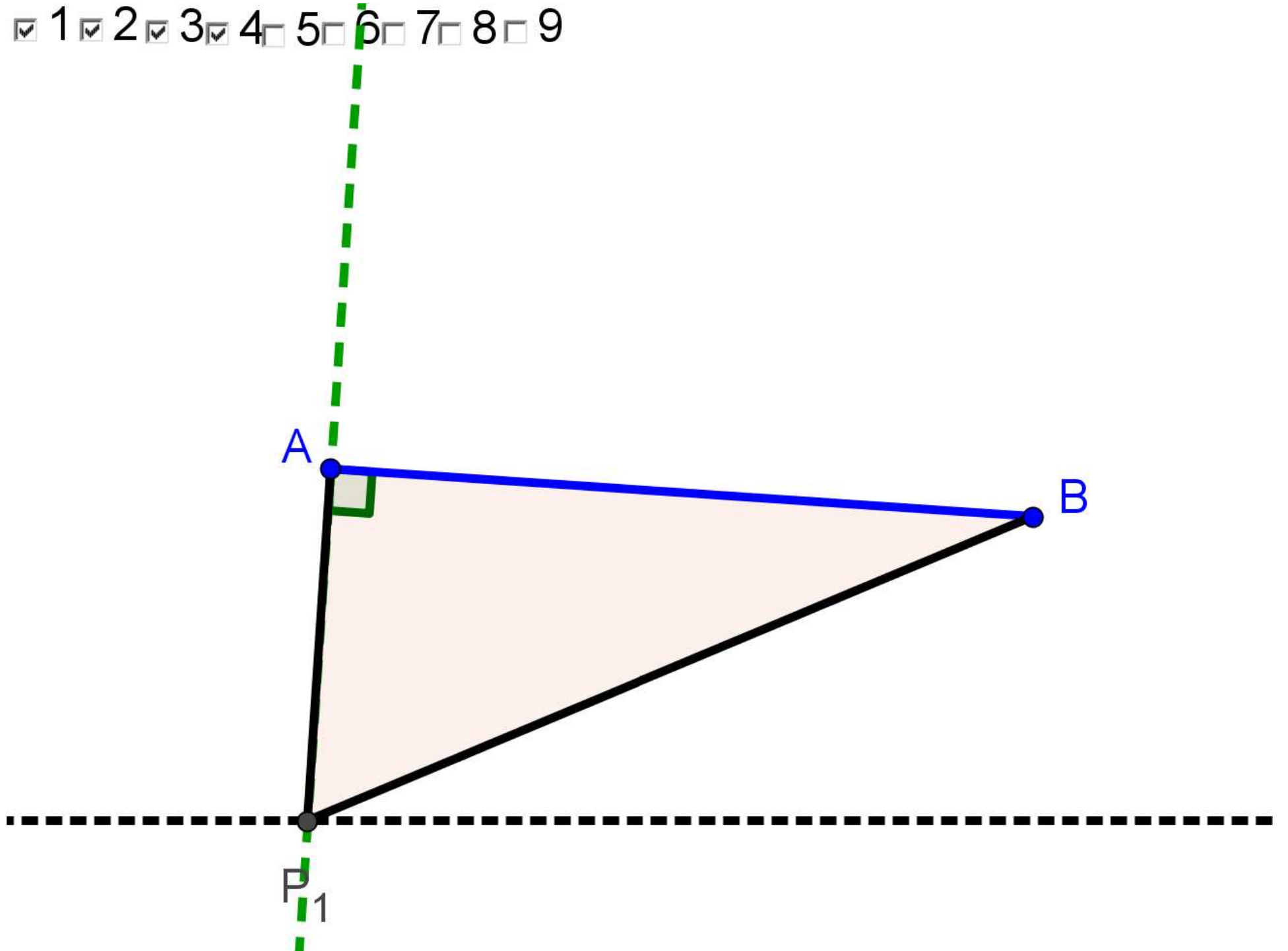

- 1
- 2
- 3
- 4
- 5
- 6
- 7
- 8
- 9

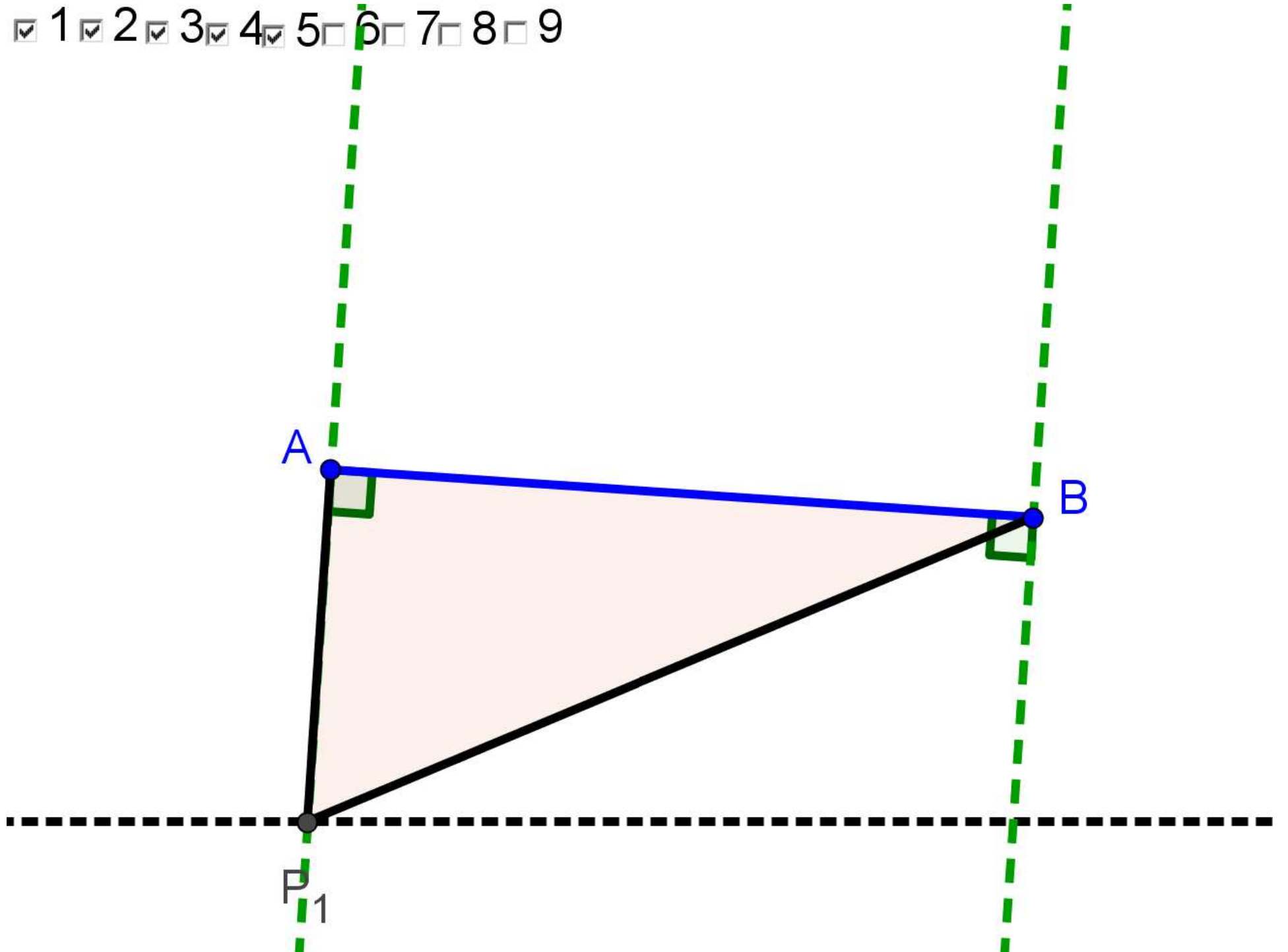

- 1
- 2
- 3
- 4
- 5
- 6
- 7
- 8
- 9

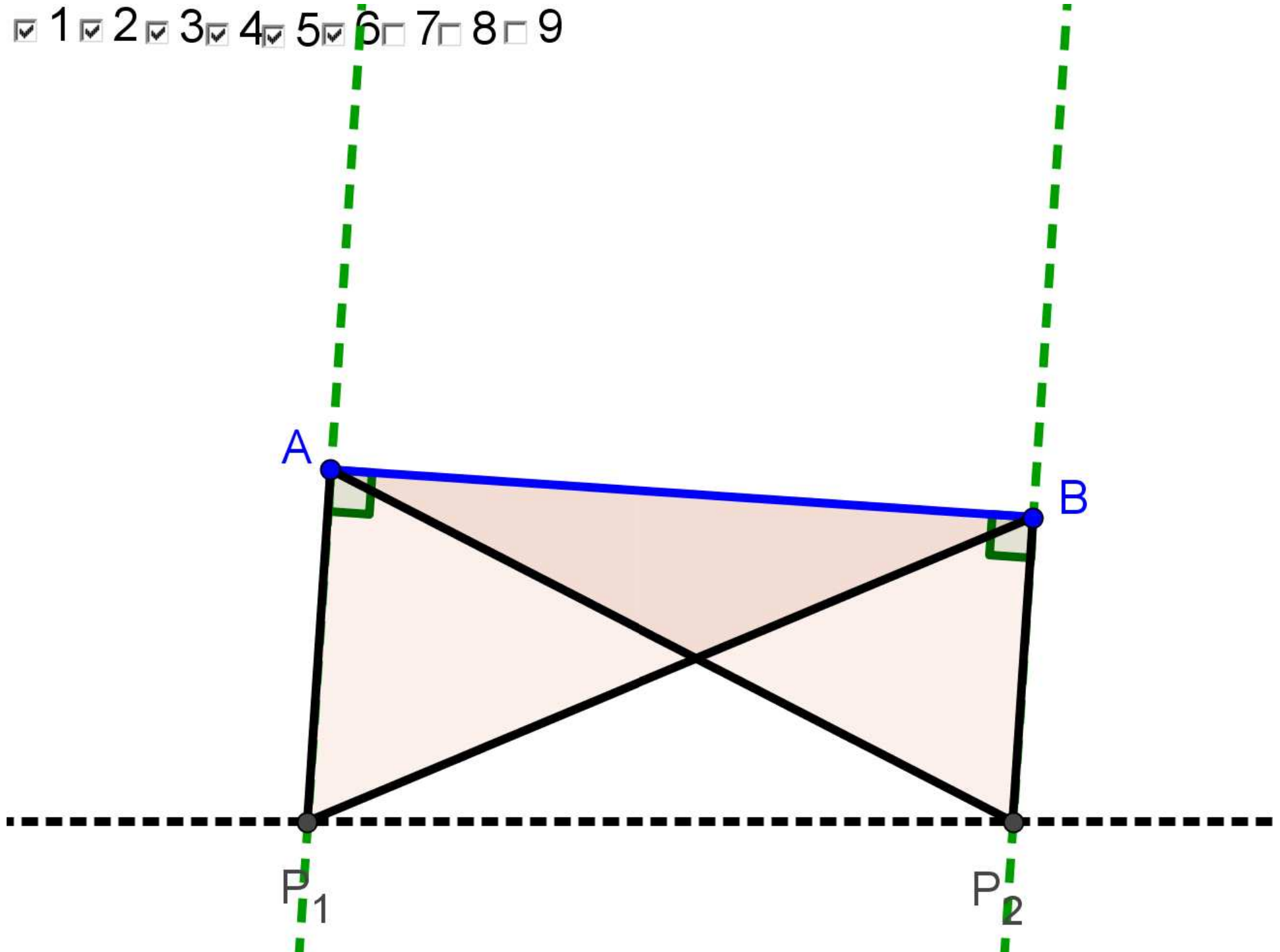

- 1
- 2
- 3
- 4
- 5
- 6
- 7
- 8
- 9

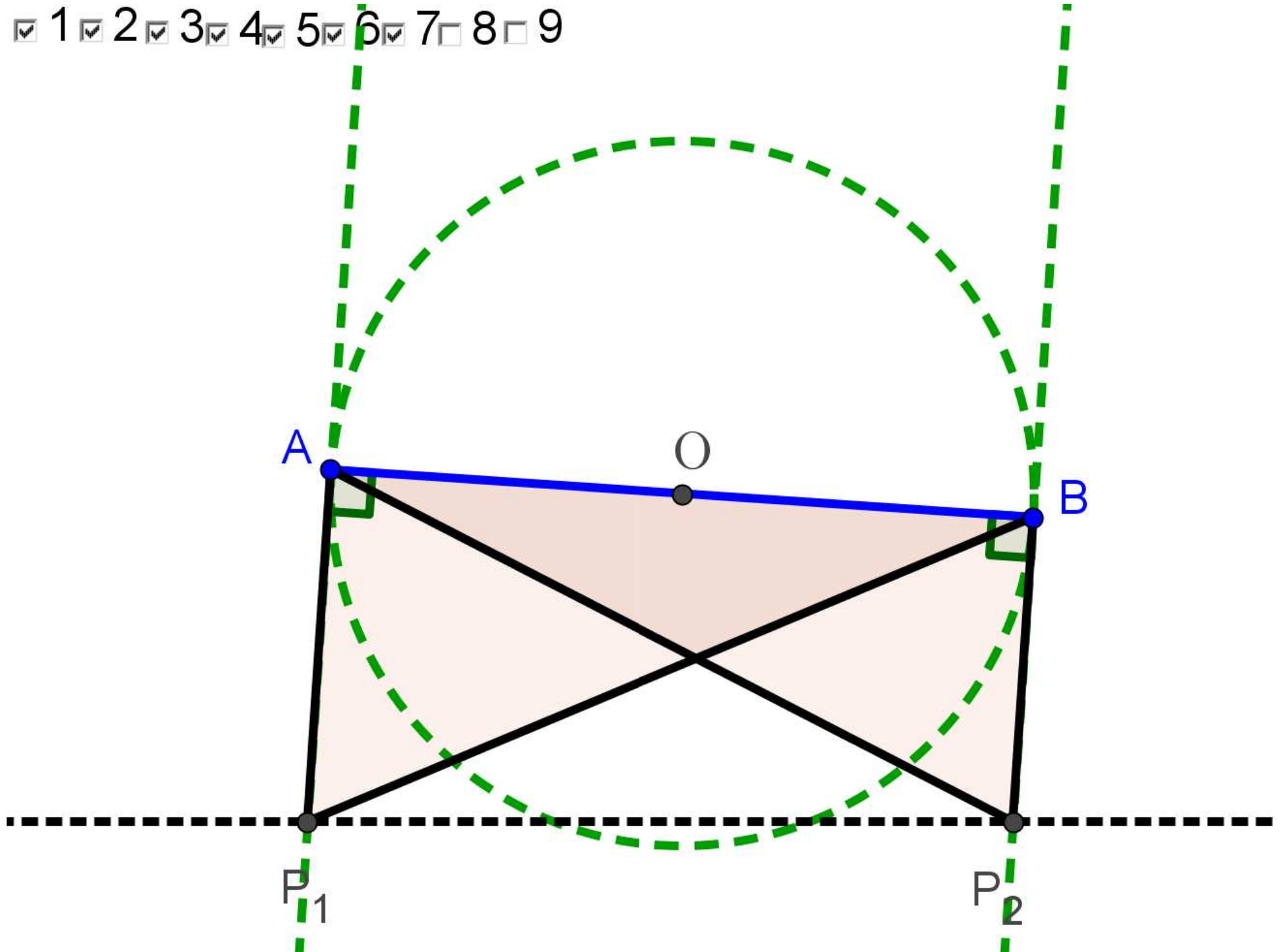

- 1
- 2
- 3
- 4
- 5
- 6
- 7
- 8
- 9

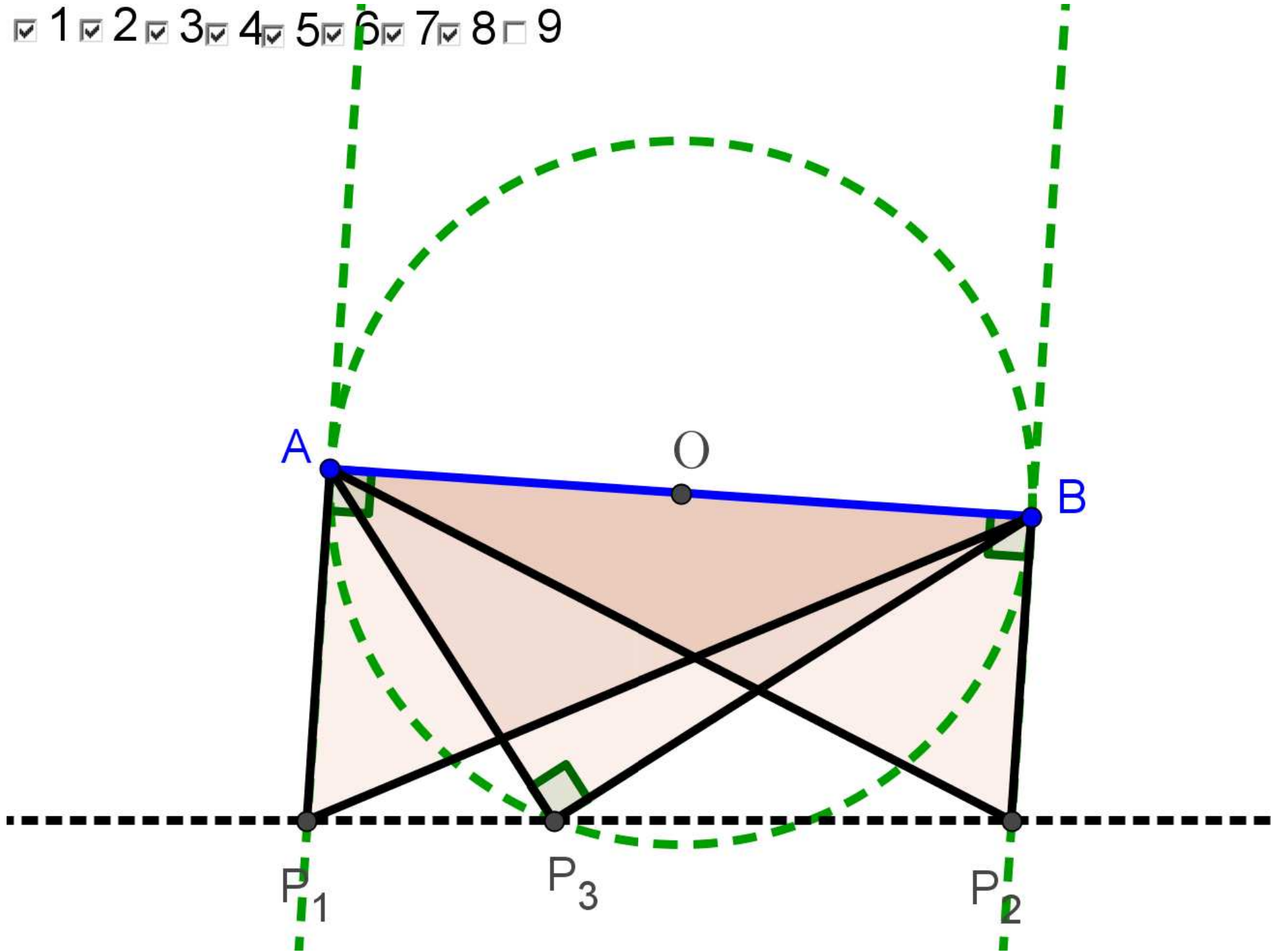

- 1
- 2
- 3
- 4
- 5
- 6
- 7
- 8
- 9

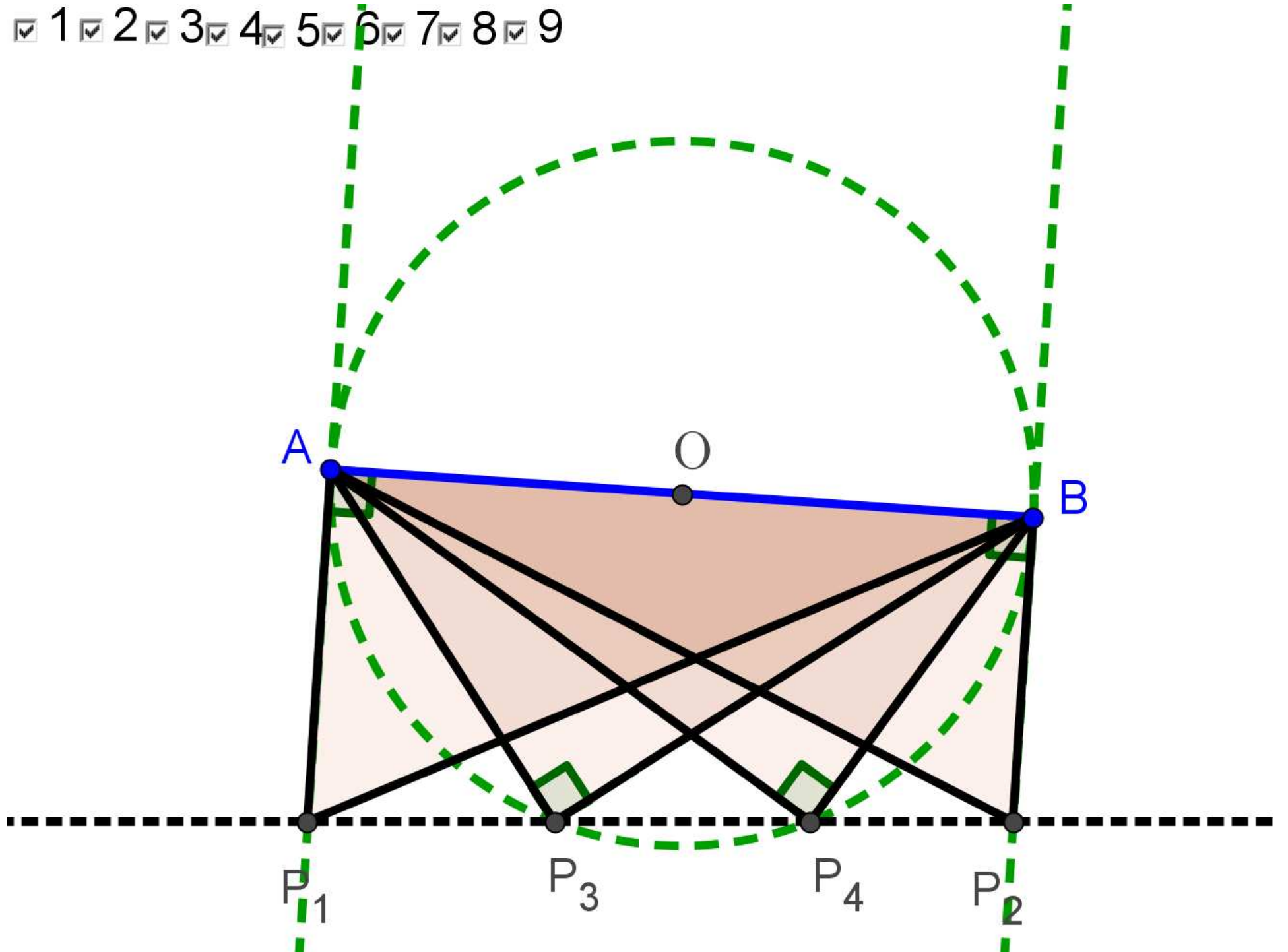

- 1
- 2
- 3
- 4
- 5
- 6
- 7
- 8
- 9

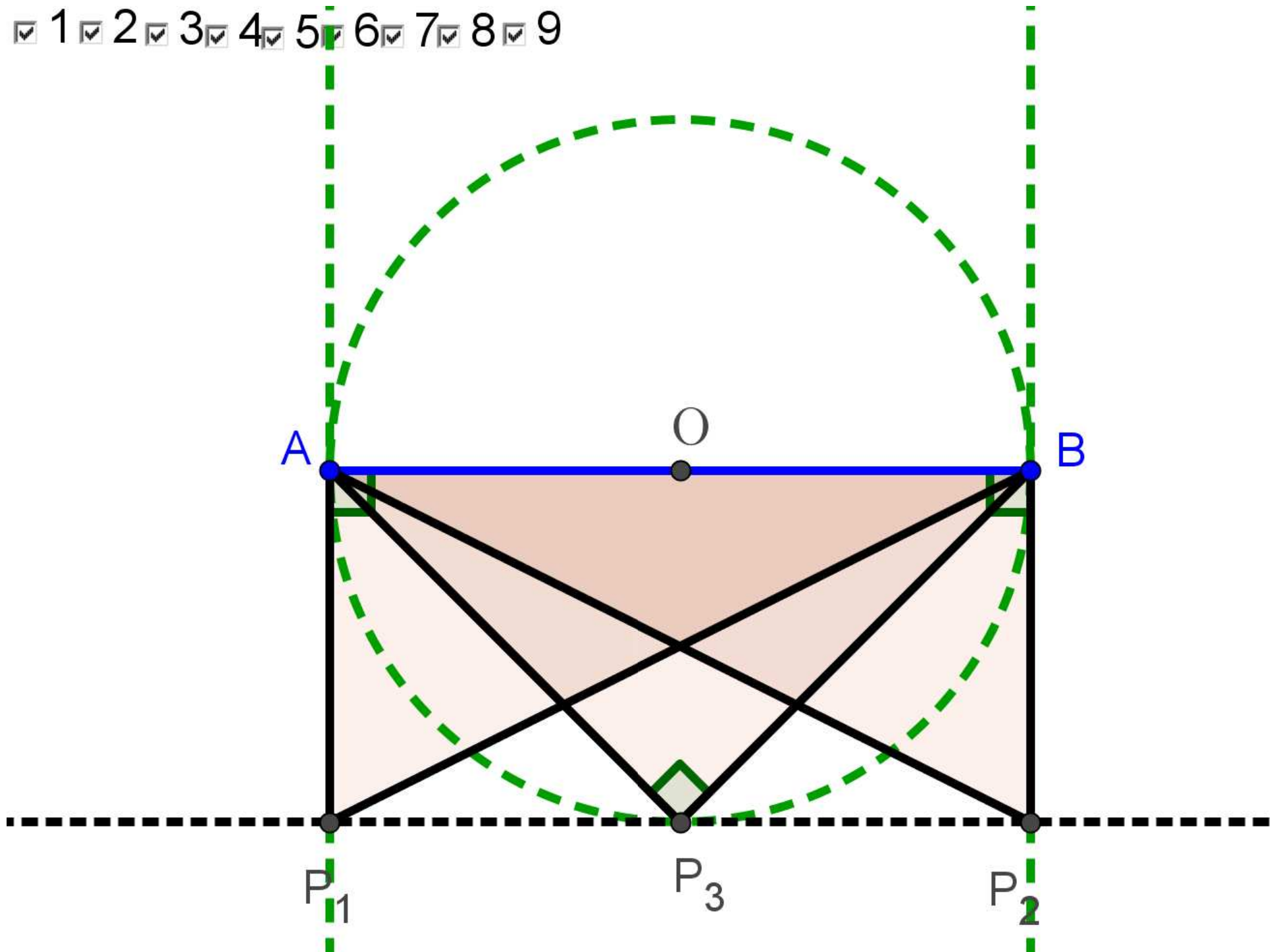

- 1
- 2
- 3
- 4
- 5
- 6
- 7
- 8
- 9

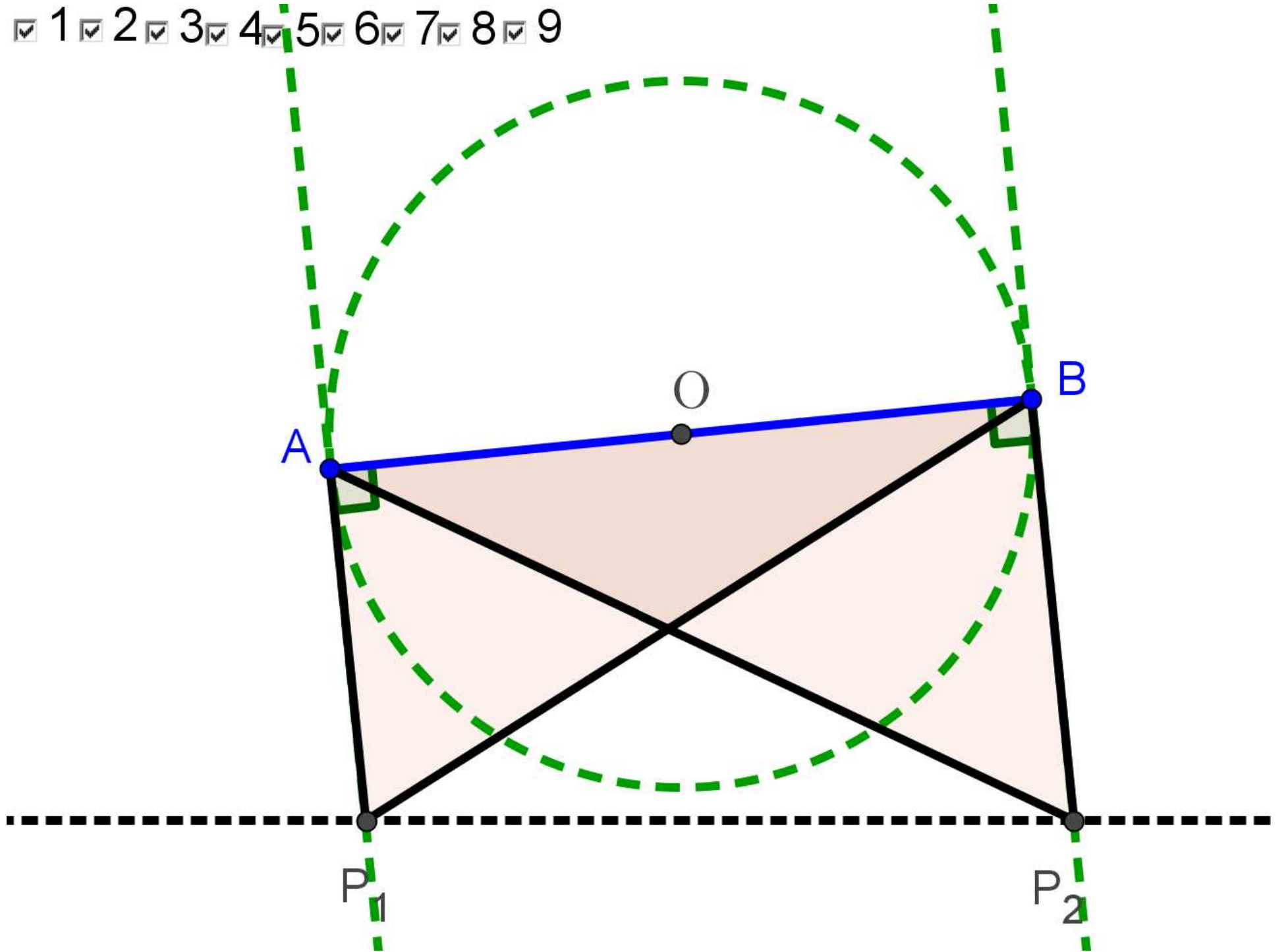

- 1
- 2
- 3
- 4
- 5
- 6
- 7
- 8
- 9
- 10

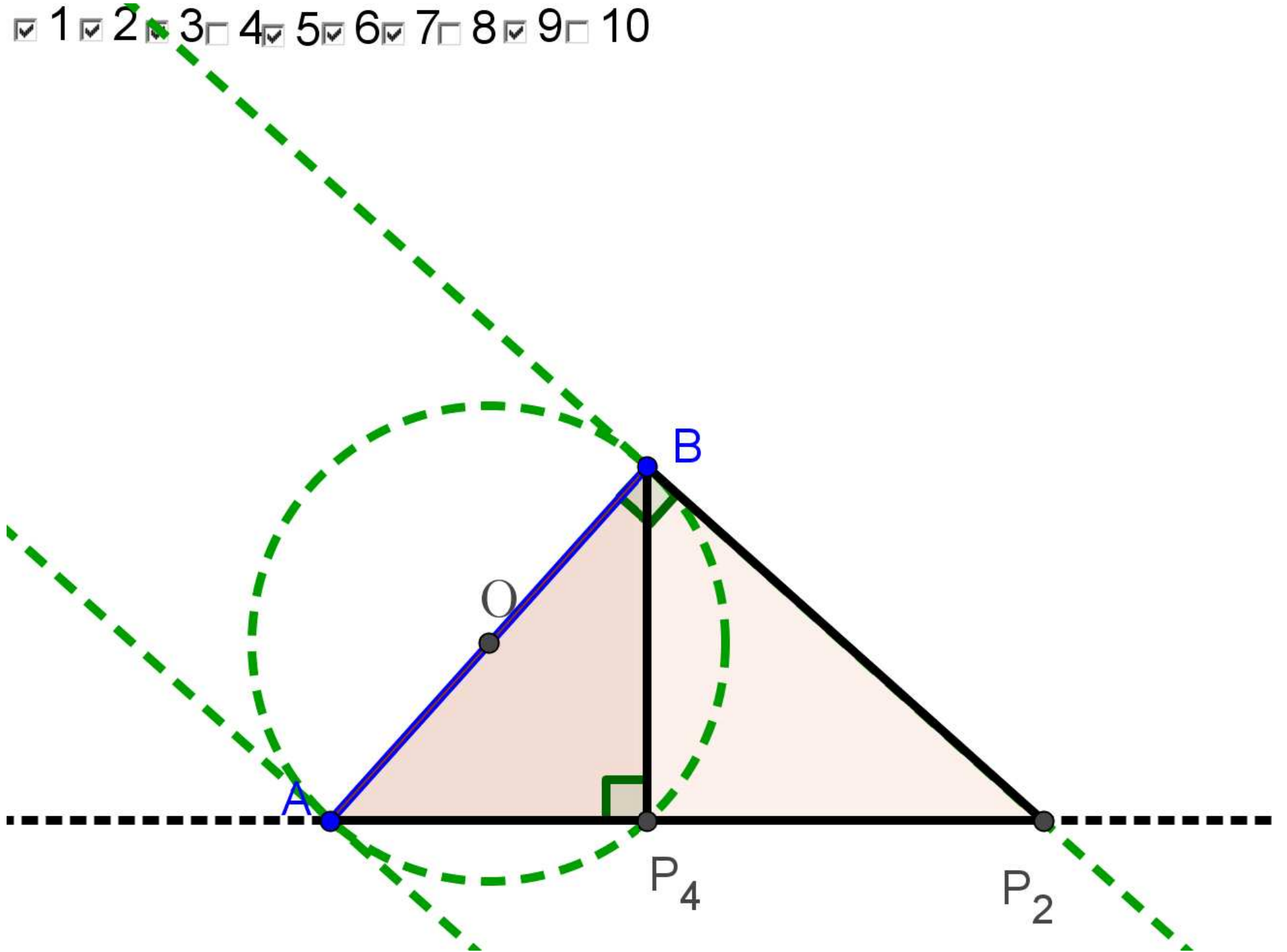

- 1
- 2
- 3
- 4
- 5
- 6
- 7
- 8
- 9
- 10

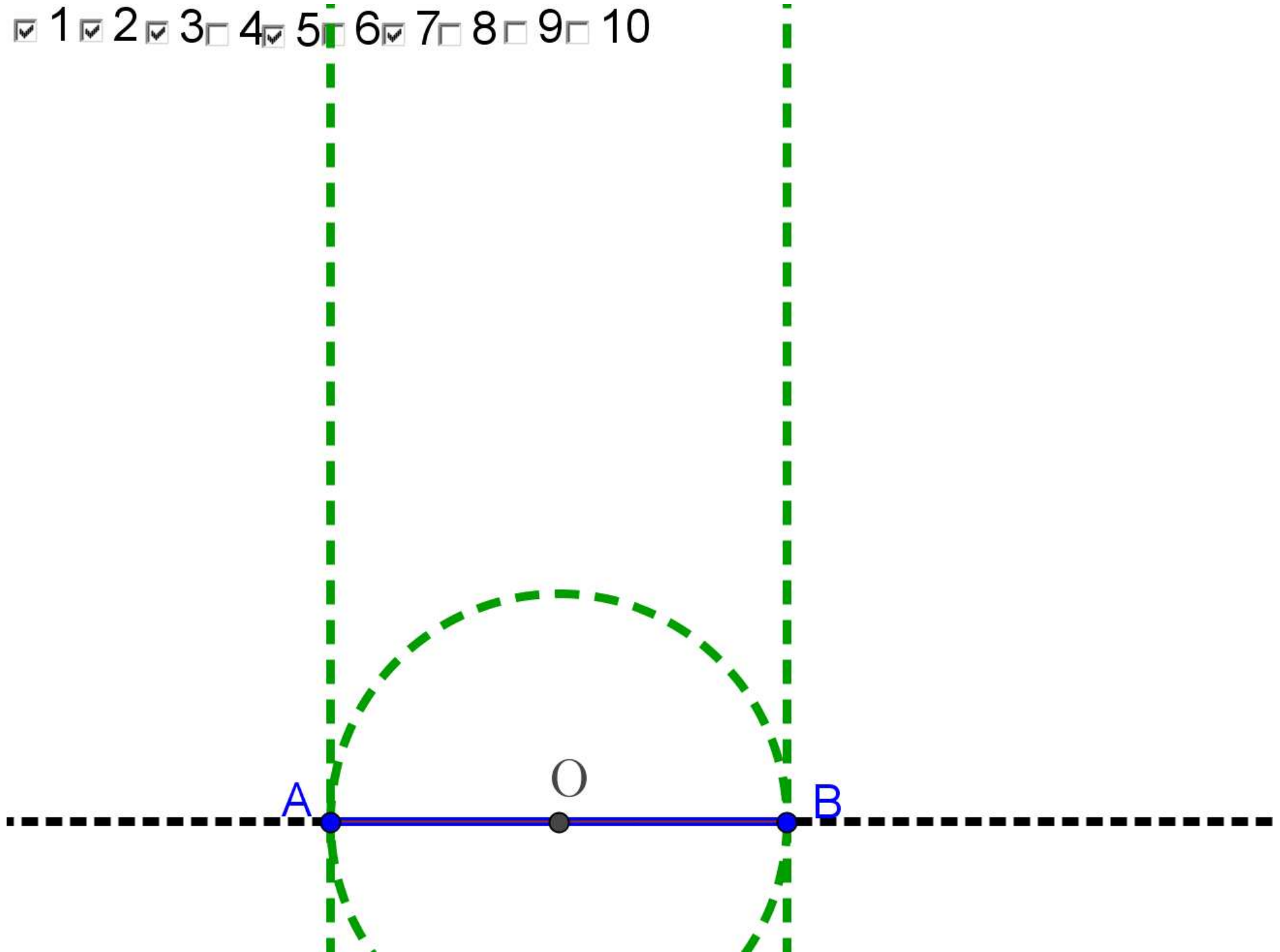

- 1
- 2
- 3
- 4
- 5
- 6
- 7
- 8
- 9
- 10

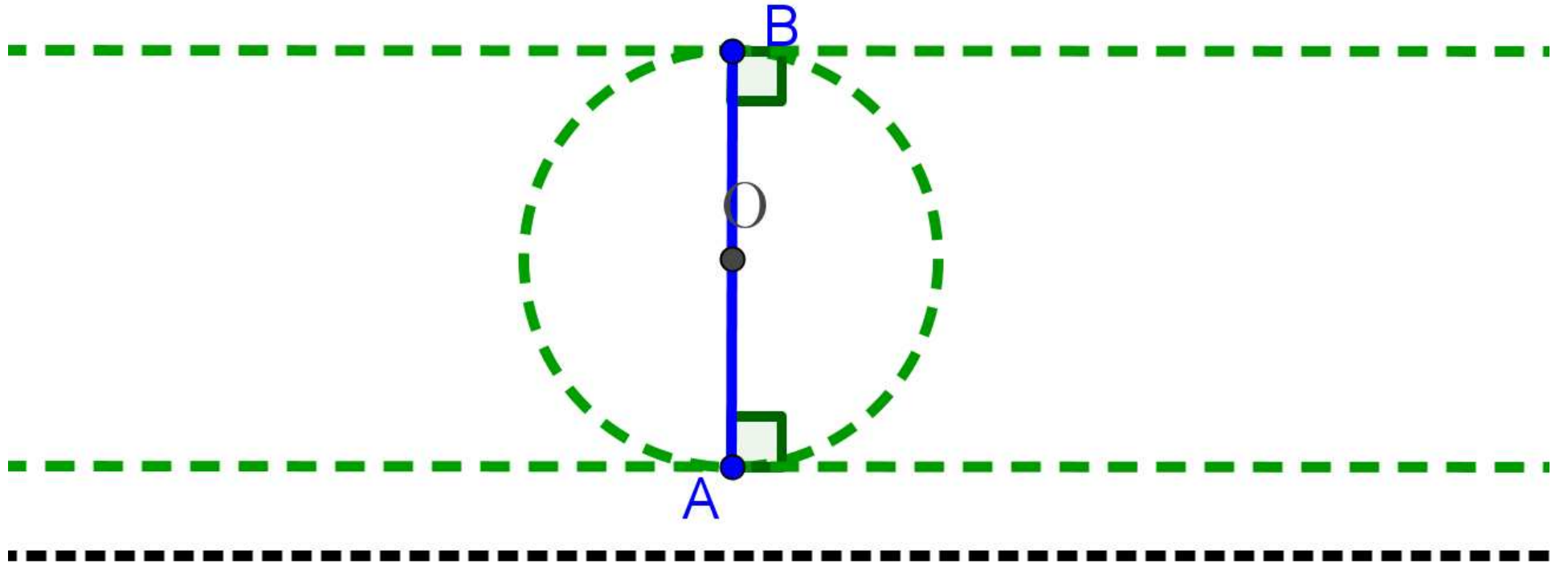

- 1
- 2
- 3
- 4
- 5
- 6
- 7
- 8
- 9
- 10

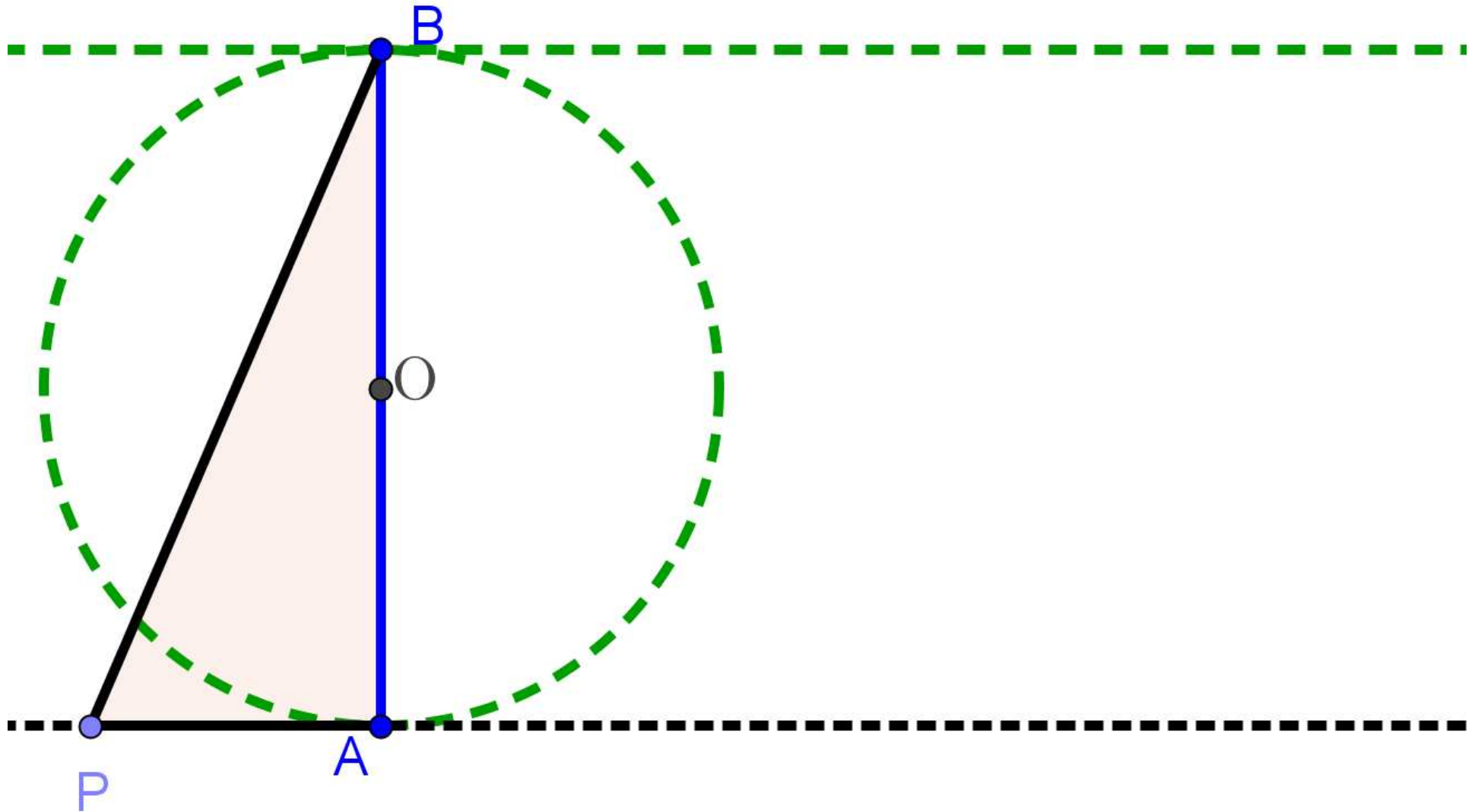

- 1
- 2
- 3
- 4
- 5
- 6
- 7
- 8
- 9
- 10

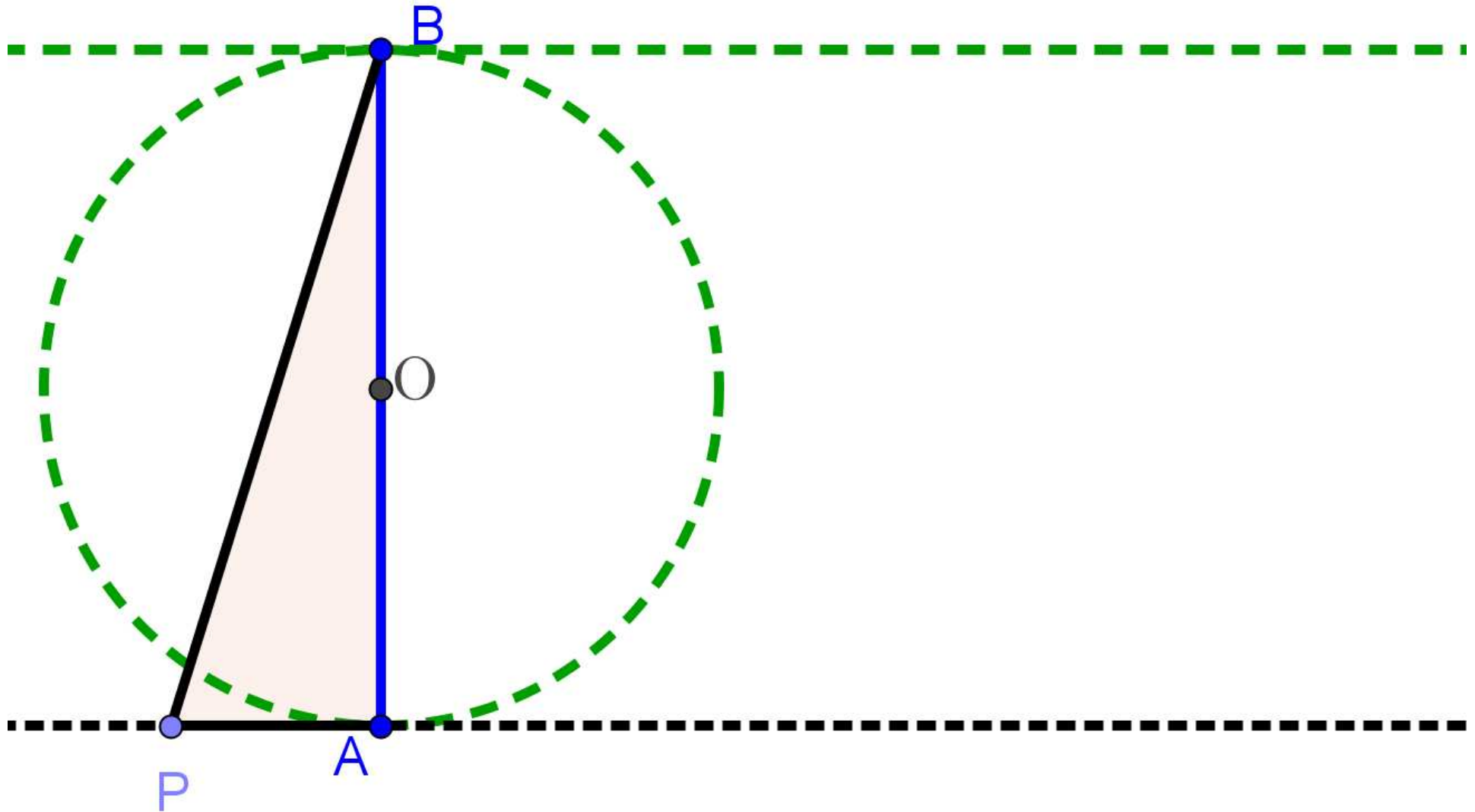

- 1
- 2
- 3
- 4
- 5
- 6
- 7
- 8
- 9
- 10

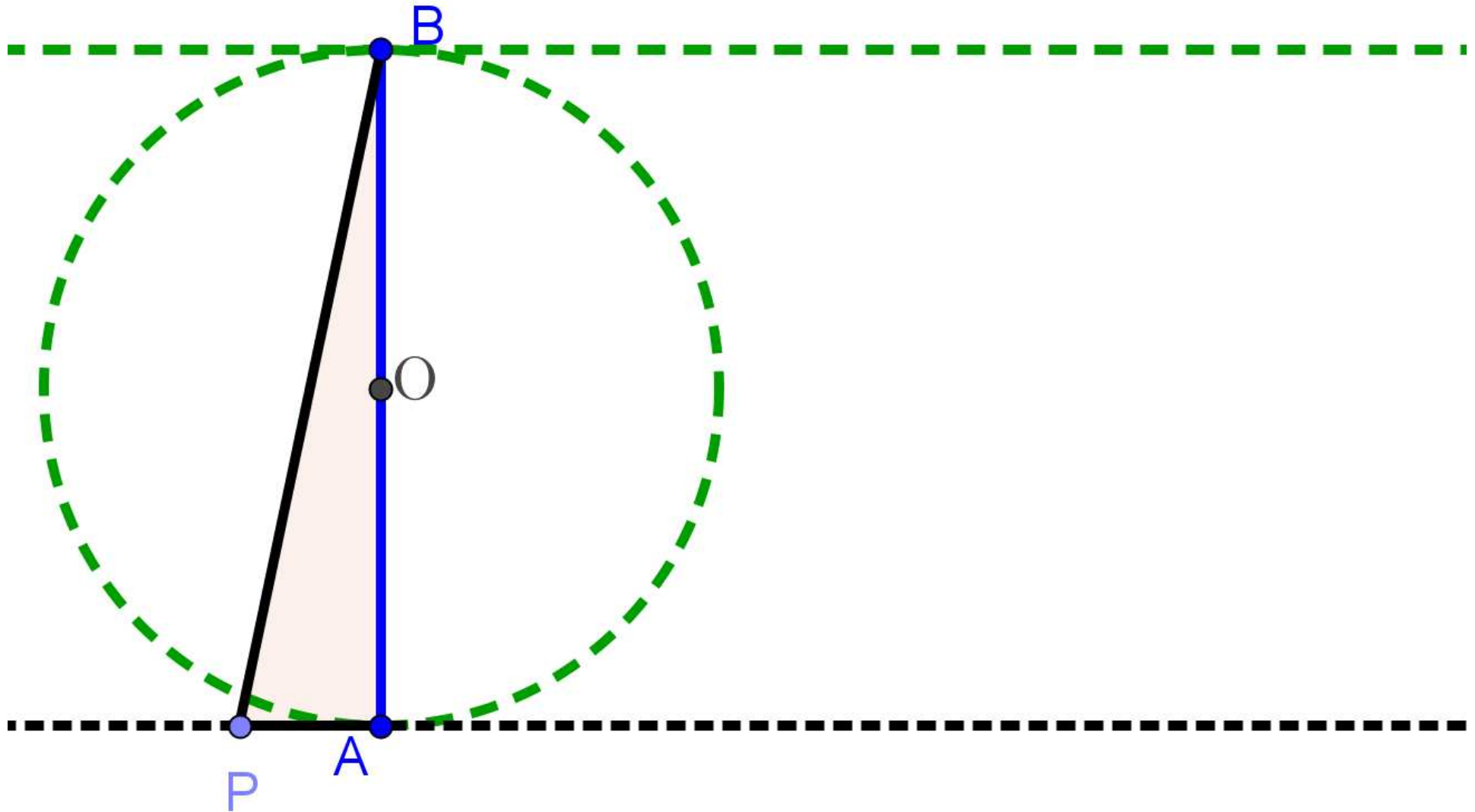

- 1
- 2
- 3
- 4
- 5
- 6
- 7
- 8
- 9
- 10

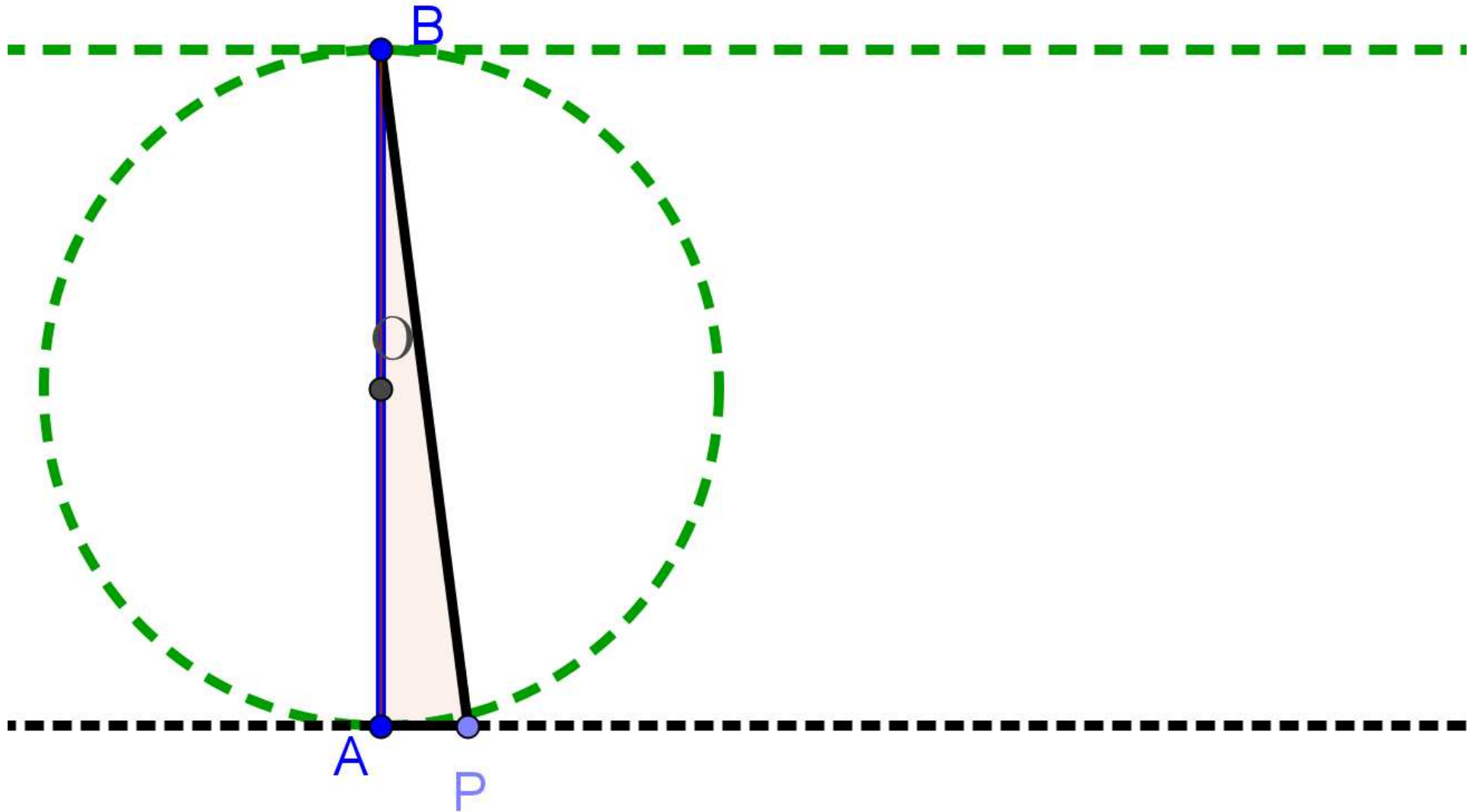

- 1
- 2
- 3
- 4
- 5
- 6
- 7
- 8
- 9
- 10

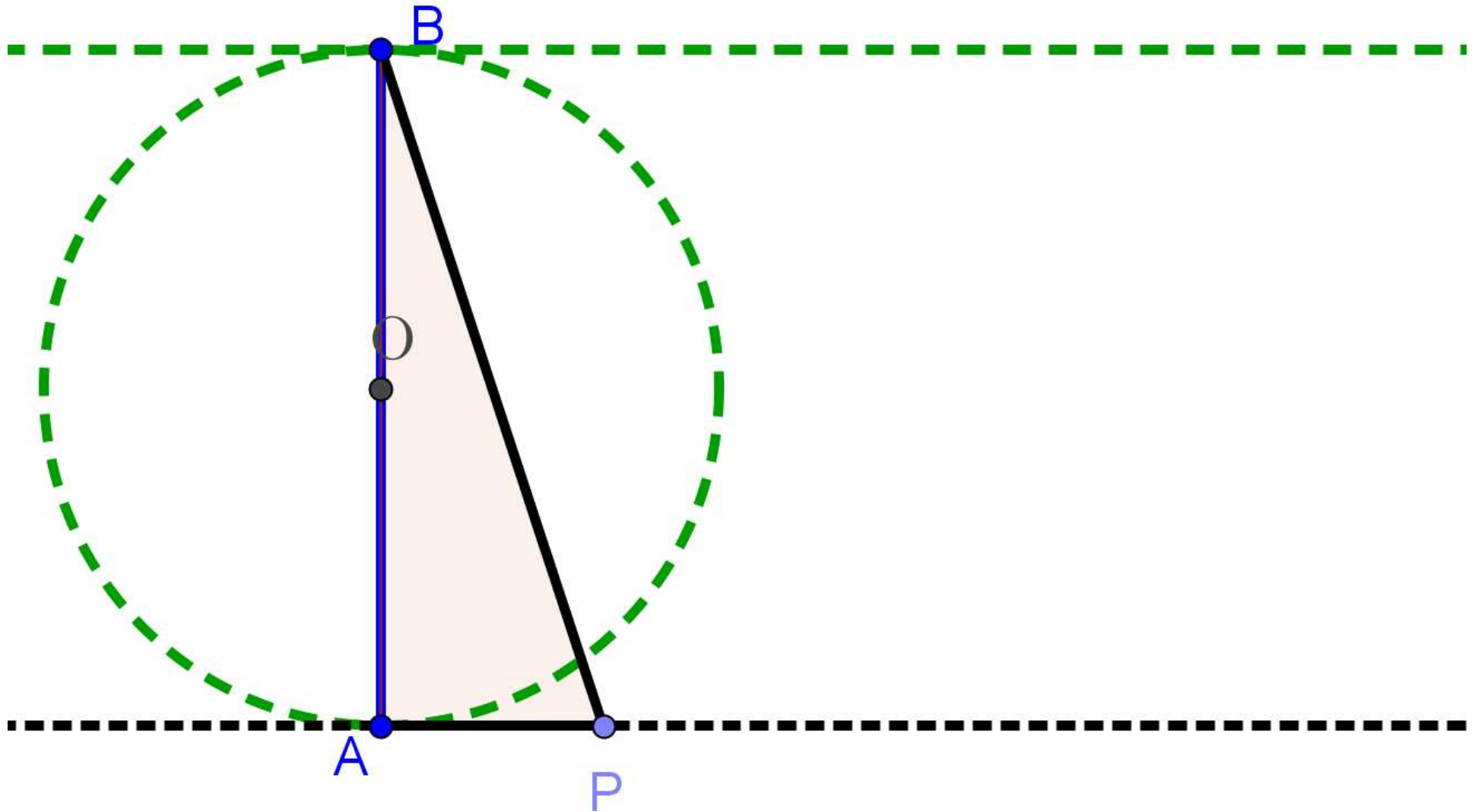

- 1
- 2
- 3
- 4
- 5
- 6
- 7
- 8
- 9
- 10

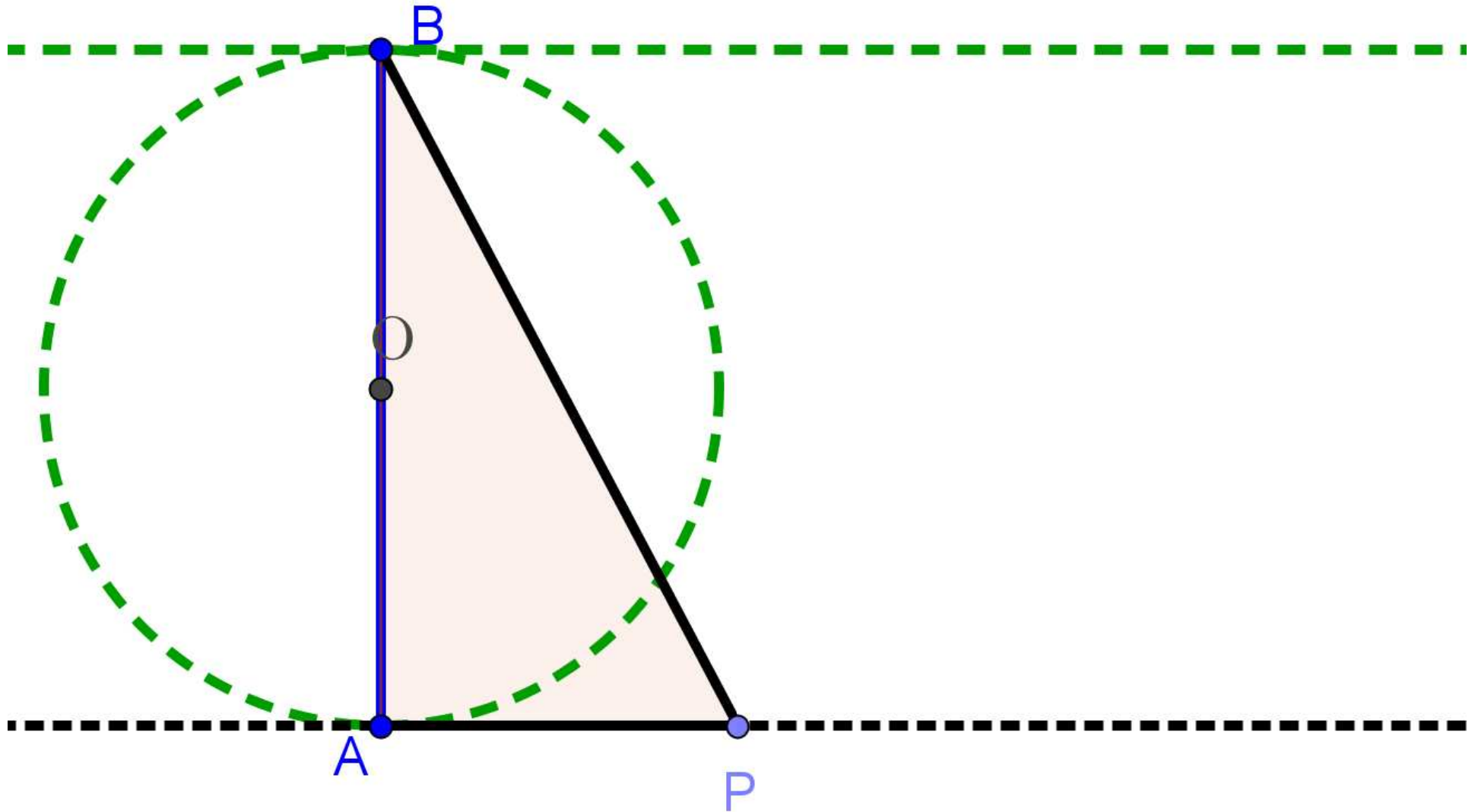

- 1
- 2
- 3
- 4
- 5
- 6
- 7
- 8
- 9
- 10

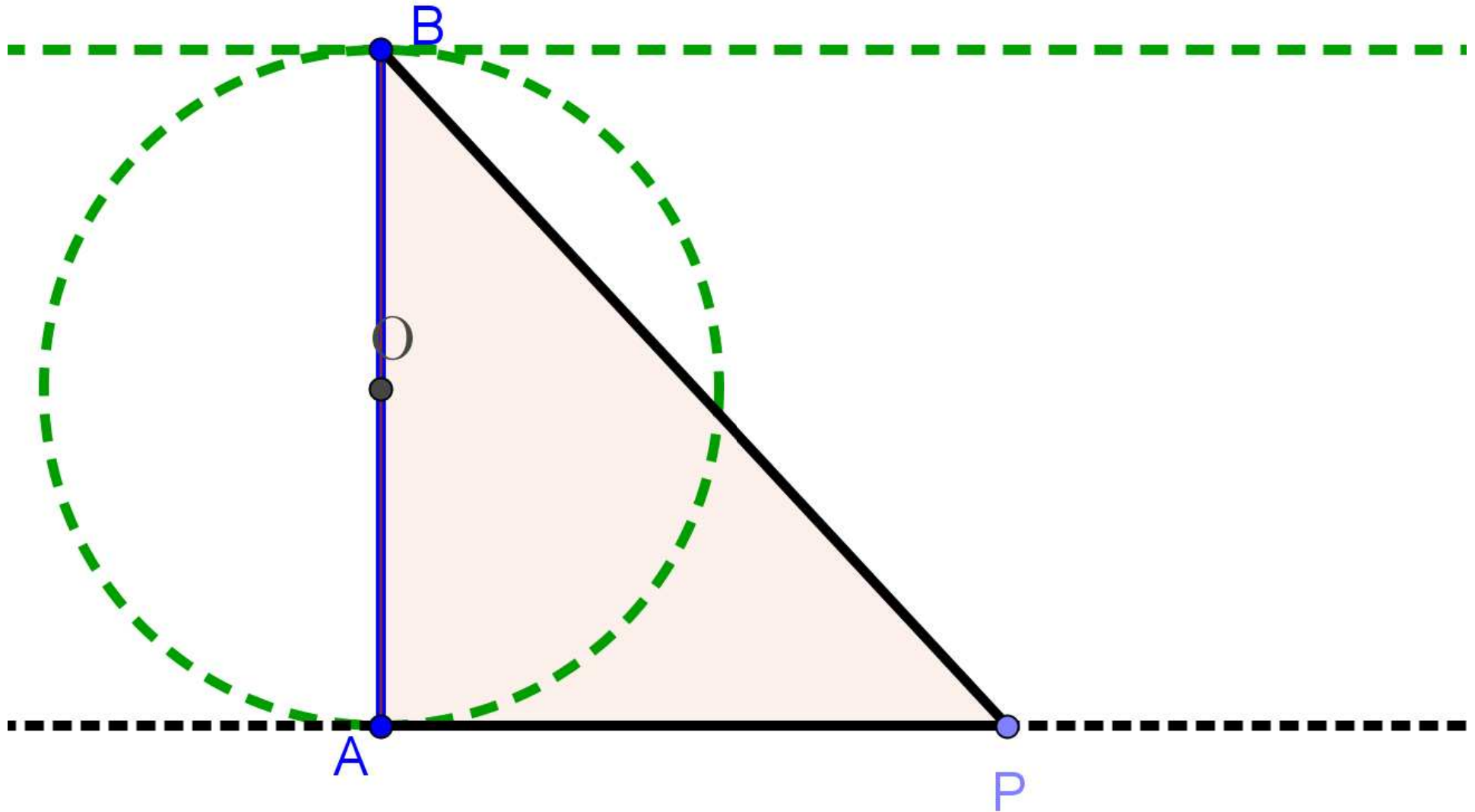

- 1
- 2
- 3
- 4
- 5
- 6
- 7
- 8
- 9
- 10

